

© DIN-13R / Round Nut

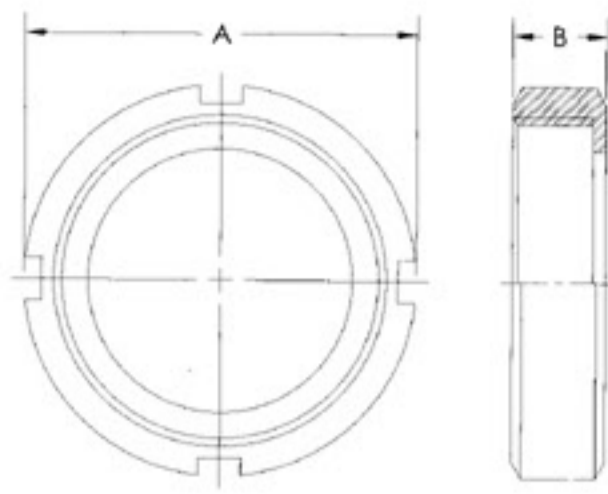

SIZE	A	B
10	38	18
15	44	18
20	54	21
25	63	21
32	70	21
40	78	21
50	92	22
65	112	25
80	127	30
100	148	31
125	178	35
150	210	40

© DIN-14 / Welding Liner

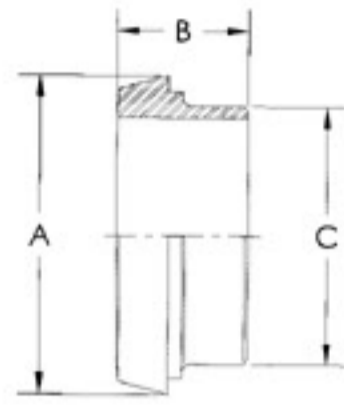

SIZE	A	B	C
10	22	17	15
15	28	17	21
20	36	18	25
25	44	22	31
32	50	25	37
40	56	26	43
50	68	28	55
65	86	32	72
80	100	37	87
100	121	44	106
125	150	54	132
150	176	65	157

© DIN-15 / Welding Male Parts

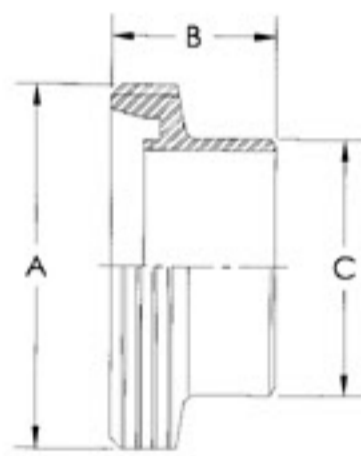

SIZE	A	B	C
10	28	21	15
15	34	21	21
20	44	24	25
25	52	29	31
32	58	32	37
40	65	33	43
50	78	35	55
65	95	40	72
80	110	45	87
100	130	54	106
125	160	65	132
150	190	80	157

© DIN-14I / Welding Liner (Imperial Size)

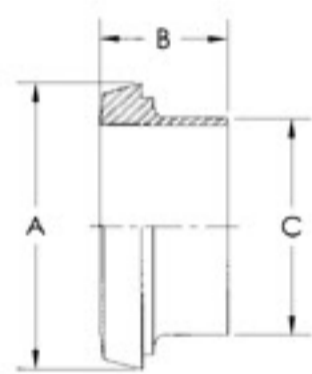

SIZE	A	B	C
1"	44.0	22.0	25.4
1.1/2"	56.0	26.0	38.1
2"	68.0	28.0	50.8
2.1/2"	86.0	32.0	63.5
3"	100.0	37.0	76.2
4"	121.0	44.0	101.6

© DIN-15I / Welding Male Part (Imperial Size)

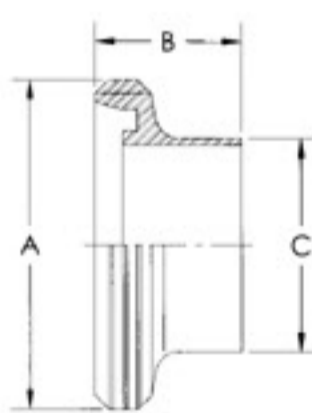

SIZE	A	B	C
1"	52.0	29.0	25.4
1.1/2"	65.0	33.0	38.1
2"	78.0	35.0	50.8
2.1/2"	95.0	40.0	63.5
3"	110.0	45.0	76.2
4"	130.0	54.0	101.6

© DIN-14R / Expanding Liner

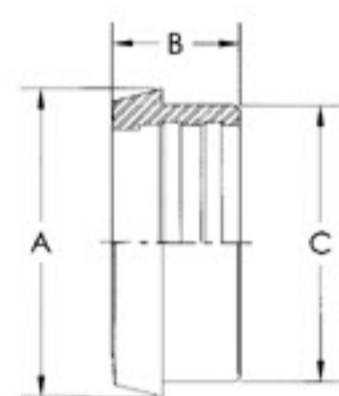

SIZE	A	B	C
10	22	17	18
15	28	17	24
20	36	18	30
25	44	22	35
32	50	25	41
40	56	26	48
50	68	28	61
65	86	32	79
80	100	37	93
100	121	44	114
125	150	54	137
150	176	65	163

© DIN-15R / Expanding Male Part

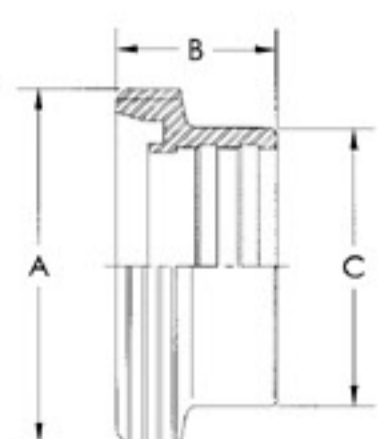

SIZE	A	B	C
10	28	21	18
15	34	21	24
20	44	24	30
25	52	29	35
32	58	32	41
40	65	33	48
50	78	35	61
65	95	40	79
80	110	45	93
100	130	54	114
125	160	65	137
150	190	80	163